

CNC SWISS-TURN



CNC SWISS TYPE AUTOMATIC LATHE

SA 20/26/32/38 (PII / PYII)



NEXTURN
SWISS TURN LEADER

Powerful Cutting, Precise Machining with Removable

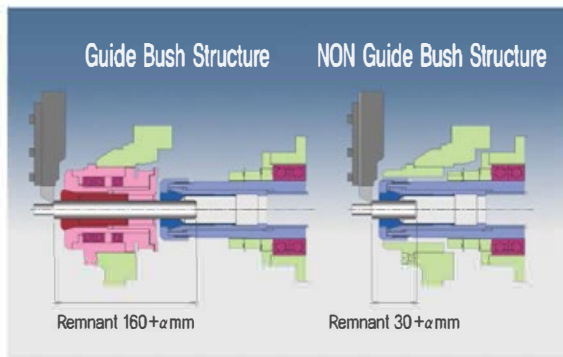
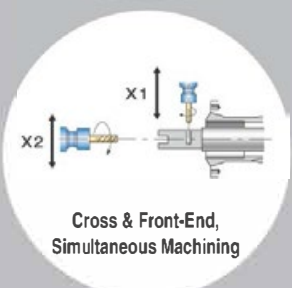
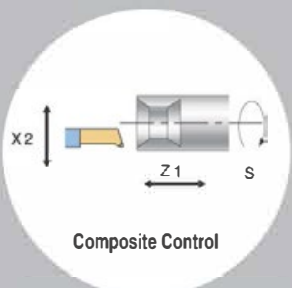
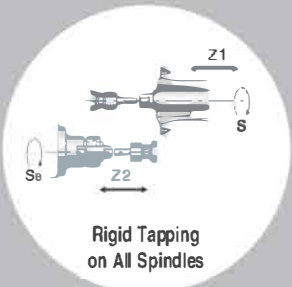
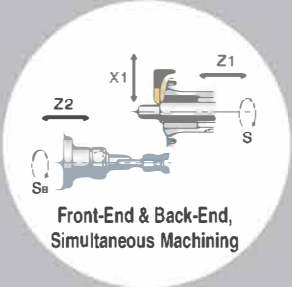
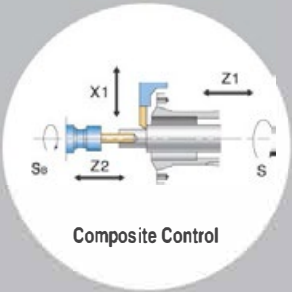

Exchangable Guide Bush, Non Guide Bush System (PY II TYPE)

- Maximise Machining depends on Work Length, due to Exchangable Guide Bush and Non Guide Bush System
- Guide Bush Type allows precision machining, Suitable for Long Part Production
- Non Guide Bush Type allows to use cheaper Drawing Bar, Minimise Bar Remnant for More Economical Production

Powerful Composite Tooling System at High Speed

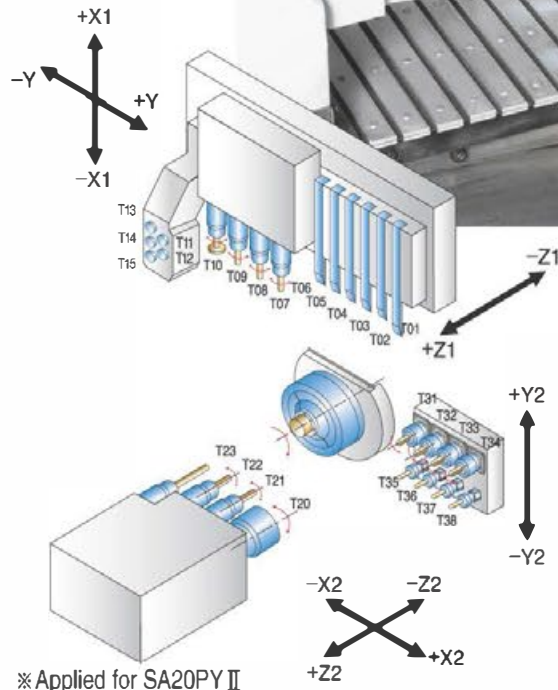

High Rigidity

- Body Structure Design by FEM Analysis Program
- Tool Stand with Low Center of Gravity Design
- One Piece Casting Bed Type with LM Guide links to Bed
- Outstanding Machining Capability with Powerful Motor and LM Guide
- Synchronous Rotary Guide Bushing Holder
- Power Chucking Toggle System
- ER16 Collet for Revolving Tool
- Rapid Traverse Speed : 32M/min.

Guide Bushing System

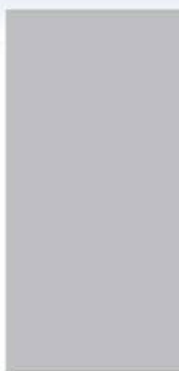

■ Easy Operation System

- Easy Positioning Operation Panel with the Convenience and MPG Mounted
- Fully Opening Type Covers & Doors (RH / LH)
- Minimized Operational Key with Software Configuration
- Easy for Trouble Check and Remedy by Modulated Pneumatic System
- Slant Bed Structure with Easy Chip Disposal / Coolant Discharge

■ High Accuracy

- Ultra Precision Ball Screw / LM Guide
- 1/1,000" Positioning, Cs for Main & Sub Spindles
- Pneumatic Brake with High Accuracy / High Rigidity for Main & Sub Spindles
- Keep Optimal Repeated Precision Level by Ball Screw Dual Pressure

■ Convenience

- Coolant Ejection from Each Tool Block
- Easy Chip Disposal with Downward Tool Direction
- Safe & Versatile Shock Protection Software
- Easy & Simple Operational Panel
- Versatile Tool Management Program

■ Reliability

- Outstanding Electric System using all Fanuc Products
- Cut-Off Tool Breakage Detector by Mechanical Sensors
- Complete Oil Block for Main Spindle Area by Dual Slide Cover
- Cable, Sensor, Main Spindle, Ball Screw Protected against Erosion or Hardening
- Regular CNC Educational Program Course Available

■ Sub Spindle Built-in Motor (except SA20P II / PY II)

- Min. Thermal Deformation by Inverter Oil Cooling System for High Precision and Accurate Machining
- Motor Output: 2.2 / 3.7kW

■ Powerful Cross Tool Station

- Upgrade 2.2kW Motor for max. Performance
- No. of Tools : 4 (Modular 2, Live 2) - P II type
5 (Modular 3, Live 2) - PY II type
- Max. Spindle Speed: 6,000rpm

■ Rotary Guide Bushing Unit

- Rotary Synchronous Type
- Dual Bearing Structure with High Accuracy
- Strong and Accurate Bearing Support on Both Ends
- Spline Shaft Driven

■ LAY-OUT

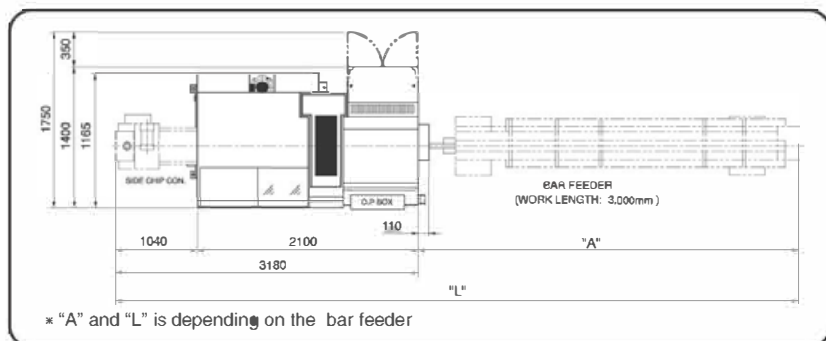

■ Powerful Back-End Tool Station

- Balanced Process by Powerful Back-End Machining Reducing Cycle Time
- Rigid Off-center Drilling and Tapping with High Speed and High Accuracy
- No. of Tools : 4 (Live 2, Fixed 2) - P II type
8 (Live 4, Fixed 4) - PY II type
- Max. Spindle Speed : 5,000 rpm
- Motor Output : 2.2kW - P II type
1.0kW - PY II type
- Back-end Face Cross Unit (Option)

■ Rigid Tapping Function

- Tap Holder not Required
- Save time with High Tapping Speed

■ Modular Type Drilling Unit (Optional)

- Simple Change for Driven Tools / Fixed Tools (Back Tools)
- Special Tool Holder Adoptable (Cross)
- Angled drilling, Whirling, Hobbing, Slotting Unit

Machine Specification

Part	Description	SA20PII	SA20PYII	SA26PII	SA26PYII	SA32PII	SA32PYII	SA38PII	SA38PYII
Machining Capacity	Max. Turning Bar Dia.	ø20mm		ø26mm		ø32mm		ø38mm	
	Max. Turning Bar Length	250mm	210mm(N:60mm)	250mm	210mm(N:60mm)	250mm	210mm(N:80mm)	250mm	210mm(N:80mm)
	Max. Main Spindle Drilling / Tapping	ø10mm / M8		ø12mm / M10		ø12mm / M10		ø12mm / M10	
	Max. Sub Spindle Chucking Dia.	ø20mm		ø26mm		ø32mm		ø38mm	
	Max. Back-end Face Drilling / Tapping	ø8mm / M6		ø12mm / M10		ø10mm / M8		ø12mm / M10	
	Max. Cross Drilling / Tapping	ø10mm / M8		ø12mm / M10		ø12mm / M10		ø12mm / M10	
	Max. Cross Disc-Mill Dia.	ø32mm		ø40mm		ø40mm		ø40mm	
Capability	Max. Main Spindle Speed	10,000rpm		8,000rpm		8,000rpm		8,000rpm	
	Max. Sub Spindle Speed	8,000rpm		8,000rpm		8,000rpm		8,000rpm	
	Max. Cross Spindle Speed	6,000rpm		6,000rpm		6,000rpm		6,000rpm	
	Total No. of Tools	23	27	20	25	20	25	19	24
	OD / Cross Live Tool / Y-Axis ID	6 / 4 / 5	6 / 5 / 5	5 / 4 / 5	5 / 5 / 5	5 / 4 / 5	5 / 5 / 5	5 / 4 / 5	5 / 5 / 5
	Front-end Face Tools (Sub)	3 (Live 2, Fixed 1)		2 (Fixed 2)		2 (Fixed 2)		1 (Fixed 1)	
	Back-end Face Tools	5 (Live 2, Fixed 3)	8 (Live 4, Fixed 4)	4 (Live 2, Fixed 2)	8 (Live 4, Fixed 4)	4 (Live 2, Fixed 2)	8 (Live 4, Fixed 4)	4 (Live 2, Fixed 2)	8 (Live 4, Fixed 4)
	Bite Shank	□12×120mm		□16×120mm		□16×120mm		□16×120mm	
	Rapid Traverse	32M / min.		32M / min.		32M / min.		32M / min.	
	Controllable Axes	7	8	7	8	7	8	7	8
	Main Spindle Positioning	Cs + 1/1,000°		Cs + 1/1,000°		Cs + 1/1,000°		Cs + 1/1,000°	
Sub Spindle Positioning	Cs + 1/1,000°		Cs + 1/1,000°		Cs + 1/1,000°		Cs + 1/1,000°		
Motor	Main Spindle	2.2 / 3.7kW		5.5 / 7.5kW		5.5 / 7.5kW		5.5 / 7.5kW	
	Sub Spindle	1.5 / 2.2kW		2.2 / 3.7kW		2.2 / 3.7kW		2.2 / 3.7kW	
	Cross Drill / Mill Unit	2.2kW		2.2kW		2.2kW		2.2kW	
	Back-end Face Tools	1.0kW	1.0kW	2.2kW	1.0kW	2.2kW	1.0kW	2.2kW	1.0kW
	Coolant Pump Unit	0.9kW		0.9kW		0.9kW		0.9kW	
	Lubrication Pump Unit	0.04kW		0.04kW		0.04kW		0.04kW	
Dimension	Coolant Capacity	280ℓ		280ℓ		280ℓ		280ℓ	
	Center Height	1,000mm		1,000mm		1,000mm		1,000mm	
	Length×Width×Height	2,100×1,165×1,660mm		2,100×1,165×1,660mm		2,100×1,165×1,660mm		2,100×1,165×1,660mm	
	Net Weight	3,300kg		3,400kg		3,500kg		3,600kg	

* Above specification may be changed without prior notice.

NC Specification

Description	PII Type	PYII Type
NC Controller	FANUC 0iTF	
No. of Controllable Axis	7	8
Axis Designation	X1, Z1, Y1, X2, Z2, C1, C2	X1, Z1, Y1, X2, Z2, Y2, C1, C2
Min. Input Increment	0.001mm	
Min. Command Increment	0.001mm (X axis : 0.0005mm)	
Max. Programmable Value	±8 digits	
Interpolation Function	Linear / Circular	
Feedrate	1~6,000mm / min.	
Feedrate Override	0~150%, 10% step	
Dwell	G04 0.001~9999.999	
ABS / INC Command	X, Z, Y, C : Absolute	
	U, V, W, H : Incremental	
Tool Offset	±6 digits	
No. of Tool Offset	64 sets	
CRT / MDI	10.4" Color LCD	
Display Language	English, Others	
Tape Memory	1 Mbyte	
No. of Registerable Program	800 sets	
Miscellaneous Function	M5 / M3 digits	
Main Spindle Function	S4 digits	
Tool Function	T4 digits	

* Above specification may be changed without prior notice.

Machine Standard

Synchronous Rotary Guide Bush Holder Unit
 Part conveyor
 M-code Air Blow
 Part Ejection Detector
 4 Spindle Cross Drill Unit (PII Type)
 5 Spindle Cross Drill Unit (PYII Type)
 Main / Sub Spindle Positioning : 1/1,000°
 Cs Control on Main & Sub Spindle
 Back Tool Unit (Fixed 4 / PII Type)
 Back Tool Unit (Live 2, Fixed 2 / PYII Type)
 Coolant Flow Detector
 Patrol Light
 Barfeeder Interface
 Service Tool Kit
 Instruction Manual
 FANUC Manual (Operator / Maintenance / Parameter)

Machine Option

Barfeeder
 Long Part Discharging Unit
 Chip Conveyor
 Back Tool Unit (Live 2, Fixed 2 / PII Type)
 Back Tool Unit (Live 4, Fixed 4 / PYII Type)
 M-code Oil Blow
 Front-end Face Revolving Unit (2)
 Cut-Off Breakage Detector
 Polygon Attachment
 Y-Axis Tool Unit
 Thread Whirling Device
 Back-end Face Cross Unit (Live 2)

NC Standard

Circle, Semi-circle Designation
 Work Coordinate Shift (G50)
 Machine Lock
 Single Block
 Software Operation Panel
 Tool Offset Display
 Input / Output Interface
 Working Hour / No. of Part Display
 Tool Radius Compensation
 Chamfer / Corner R
 Automatic Power-Off
 Inch / Metric Conversion
 Back-ground Editing
 Constant Surface Speed Control
 Synchronous / Composite Function
 Z1-Z2 Synchronous Function
 MPG(handle wheel) : 0.001mm
 Synchronous Control (Main & Sub)
 Rigid Tapping on All Spindles

NC Option

MPG Program Check
 IC Card
 Additional G-Code
 Remote Control System (Ethernet)
 Fanuc Warranty Service (2 years)
 Helical Interpolation
 3 Dimensional Coordinate Conversion

NEXTURN
SWISS TURN LEADER



ISO 9001 / 14001
 Registered Firm

- 35, Giheungdanji-ro, 121beon-gil, Giheung-gu, Yongin-si, Gyeonggi-do, Korea
 TEL:82-31-288-2092
 FAX:82-31-288-2094
- E-mail : overseas@nexturn.co.kr
- Homepage : http://www.nexturn.co.kr

Your contact for CNC machines of the
 Nexturn brand in Switzerland and Liechtenstein:

SPINNER

Tel. +41 52 301 21 55
 Fax +41 52 301 21 54
 info@spinner-ag.ch
 www.spinner-ag.ch

Spinner AG
 CNC-Präzisionsmaschinen
 Hauserstrasse 35
 CH-8451 Kleinandelfingen